

# Systems and Concepts for Repair and Strengthening



## Systems and Concepts for Repair and Strengthening of Bridges and other Structures

Concrete is a durable and relatively maintenance-free construction material. Nevertheless, repair and/or strengthening of existing structures may become necessary due to

- natural aging, inadequate design, poor quality of materials, faulty construction practices
- severe environmental and accidental influences (e.g. overloads, vehicular impacts, strong earthquakes, hurricanes, fire)
- changes in use (e.g. load enhancement beyond the original design values)
- increased safety requirements.



DSI can assist you at any or all stages of a repair/strengthening project:

- inspection and condition evaluation of structures
- preparation/review of the repair/strengthening scheme
- design and dimensioning of the strengthening work
- supply and installation of high quality DYWIDAG products
- execution of the strengthening works
- site supervision with quality assurance
- monitoring and inspection controls.



DSI and DYWIDAG have more than thirty years of experience in the field of repair and strengthening works. Alongside traditional methods and systems, special repair and strengthening techniques have been developed and applied with success.

For your repair or strengthening project you can use the following well proven DYWIDAG systems:

restoring corrosion protection of prestressing steel	vacuum grouting	page 5
restoring corrosion protection of ordinary reinforcement	cathodic protection	page 5
improving interaction between old and new concrete	short bar tendons, strand tendons	pages 6-7, 11-13
strengthening of bridges	external bar and strand tendons, ground anchors	pages 7-9
strengthening of historic buildings	bar tendons, GEWI® bars	page 9
modification/expansion of existing structures	GEWI® bars, bar tendons, stay cables	page 10
seismic retrofitting of bridges	bar and strand tendons	pages 11, 12
seismic retrofitting of buildings	bar tendons, GEWI® piles	page 12
stabilizing of dams	rock anchors	page 13
seismic retrofitting of foundations	ground anchors, GEWI® piles	page 14
lifting/moving of structures	lifting system using prestressing bars	page 15

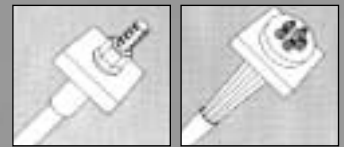
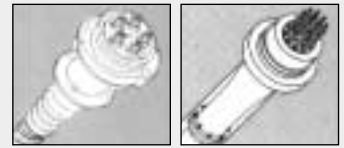
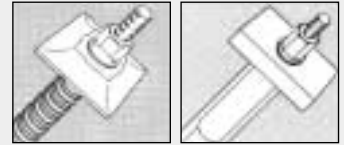



## Inspection and condition evaluation of structures

The efficiency of any repair or strengthening scheme depends very much on an accurate assessment of the actual state of the structure. Testing and inspection methodology should be based on an incremental strategy: the type and extent of further testing are decided as deficiencies are uncovered.

Although non-destructive testing methods are usually preferred, they should be complemented by destructive methods as needed to obtain a clear understanding of the nature, causes and extent of the defects.

### Point Beach Nuclear Power Plant, Two Rivers, Wisconsin, USA

Inspection of the post-tensioning tendons of two containment structures was carried out according to the safety specifications of the US Nuclear Regulatory Commission. Both visual and physical inspection (lift-off, detensioning and tensile tests) were carried out on selected tendons from all tendon groups (hoop, vertical and dome tendons).



++++ DSI Services +++++  
inspection, testing, detailed report



++++ DSI Services +++++  
Elaboration of inspection program and evaluation system, inspection, detailed report on quality and state of the relevant parts

### Autopista del Sol, Cable Stayed Bridges, Mexico

Four cable stayed bridges between Cuernavaca and Acapulco were inspected. First a detailed inspection program with a numerical and qualitative rating system was developed. A detailed report on the quality and state of the main parts of each bridge, especially superstructures, pylons and stay cables as well as recommendations on remedial measures were proposed to the owner.

## vacuum grouting

### Restoring corrosion protection of prestressing steel

Where ducts are not completely filled with cement grout, subsequent grouting must be carried out. This can be accomplished by vacuum grouting. The advantage of this procedure is that regrouting of the duct requires only one drilled hole for each void.

Special devices and techniques have been developed by DSI for careful drilling of ducts to avoid damaging the prestressing steel. The volume of the void is measured by creating a vacuum, which also sucks the grout into the void. A comparison between the measured volume of void and the amount of grout consumed provides a control measure on the success of the operation.



### Bridges on the Brenner Highway, Austria

Many ducts in prestressed bridges of the Brenner Highway were checked for quality of grouting. The detected voids were vacuum grouted.

## Restoration of Corrosion Protection

One of the most important tasks of civil engineers to ensure the durability of structures is the corrosion protection of steel elements.

DSI offers efficient and advanced methods for restoring corrosion protection of both, prestressing and reinforcing steel.

## cathodic protection

### Restoring corrosion protection of reinforcing steel

Besides the traditional corrosion protection methods in which the carbonised or the chloride-contaminated concrete is mechanically removed and replaced with new alkaline concrete, DSI has employed a highly reliable electrochemical corrosion protection method: cathodic protection (CP).

A low intensity direct current (5-20 mA/m<sup>2</sup>) is continuously applied between the reinforcement (the cathode) and a durable anode (made for example of titanium) which is embedded into a cementitious overlay on the old concrete surface. The efficiency of the CP measure is controlled through potential measurements on the embedded reference cells. This protection measure is more economical than traditional methods, as only the mechanically damaged concrete must be removed whereas the chloride contaminated concrete may be left undisturbed.

+++ DSI Services +++  
consultancy during assessment of the actual state of the piers, elaboration of repair programme, dimensioning of the CP system, supply and installation of the CP system.

### Outer Noesslach Bridge, Brenner Highway, Austria

The concrete of the 50 m high piers at the buttresses of the 180 m long arches was highly chloride contaminated up to a depth of 60 mm due to twenty years of exposure to de-icing salts. CP was applied to 1,500 m<sup>2</sup> of the concrete surface, as only this measure did not jeopardize the load-bearing capacity and stability of the bridge. Efficiency and performance of the CP system can be monitored at any time through potential measurements.

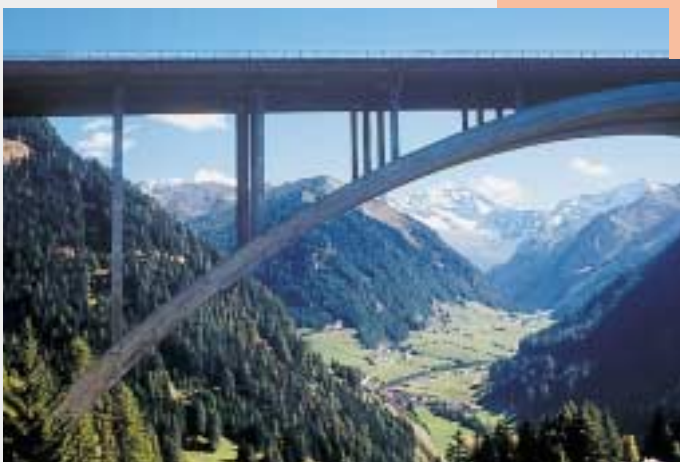

## Strengthening of Structural Members

Strengthening of structural members can be achieved by

- replacing defective, or poor quality material
- attaching additional load-bearing material (for example: reinforcement, high quality concrete, thin metallic or non-metallic straps, post-tensioning tendons, or various combinations of these methods)
- redistributing action effects through imposed deformation of the structural system.

### Interaction between the original and the new concrete parts

One of the main problems encountered in strengthening is how to achieve compatibility and interaction between the existing structure and the strengthening elements.

The force transfer across the joint between old and new concrete can be accomplished in different ways:

- simple friction between surfaces of the existing concrete and the prefabricated concrete member (dry joint)
- simple bond between the existing concrete surface and the concrete of the new part cast on site (wet joint)
- the efficiency of both joints can be considerably improved through increasing the force normal to the joint.

This may be easily achieved by post-tensioning. For this purpose DYWIDAG tendons can be employed. In the case of very short tendons, the fine thread at the end of the smooth bar results in an anchorage with an extremely small slip. In the case of short tendons, where bond is required, bar tendons using DYWIDAG bars (THREADBAR®) may be used. For longer and curved tendons, strands offer a solution.

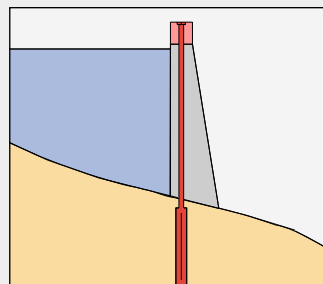
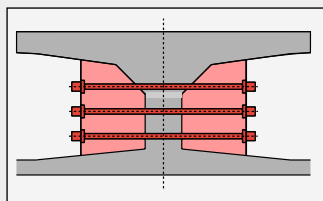
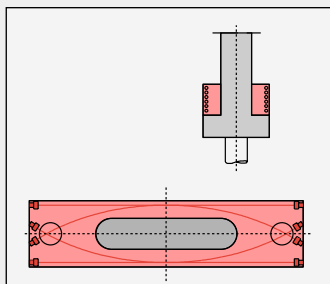

+++ DSI Services +++  
preparation of the rehabilitation scheme, supply of steel grillages and DYWIDAG bar tendons, execution of the strengthening works.



### MRT rapid transportation network, Muza Line, Taipei, Taiwan

In 1994 cracks were discovered in the concrete corbelled pier caps of the Muza line steel girder viaduct. The emergency repair scheme consisted of placing external  $\varnothing 36$  mm DYWIDAG bar tendons (THREADBAR®) on both sides of the pier cap. These were anchored in steel grillages at each end of the caps and were supplied with DYWIDAG double corrosion protection system. All exposed steel parts of the grillages were protected by a three coat paint system. On selected tendons permanent load cells were installed to monitor the prestressing forces.

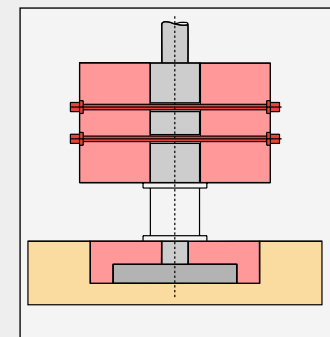
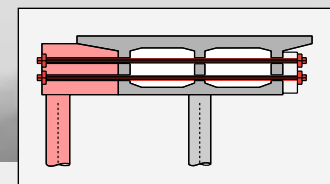



## external bar and strand tendons

### Strengthening of bridges

Bridges of any material can be strengthened by adding external post-tensioning tendons. The influence of post-tensioning on serviceability and ultimate limit states can be varied within wide limits by selecting different methods of introducing prestressing forces and using various tendon profiles.

### Won Hyo Bridge, Seoul, South Korea

The 1,120 m long bridge over the Han River was completed in 1981. Because of inaccurate calculations of prestressing losses and deflections caused by creep and shrinkage of concrete, additional deflections of up to 30 cm occurred. These resulted in 5 cm to 20 cm sagging at the hinges. The DSI rehabilitation concept called for external tendons, which on the one hand slightly reduced deflections and on the other strengthened the structure. The remaining sag could be eliminated by an additional asphalt layer. Twelve 19 x 0.6" DYWIDAG tendons were applied in each cantilever and anchored in new concrete buttresses cast inside the box girders. These were connected to the concrete of the existing webs of the box girder through friction created by the means of short  $\varnothing$  36 mm DYWIDAG smooth bar tendons.



### Rio Lima Bridge, Viana do Castelo, Portugal

Opened in 1878, this landmark in the northern Portuguese coastal town of Viana do Castelo was designed and built by A.G. Eiffel. Strengthening of this ten span, 562 m long steel bridge with two main truss beams of 7,5 m depth became necessary to adapt the load-bearing capacity to modern road and railroad traffic. However, the characteristic architecture should not be impaired through the construction measures. The consultant decided to install tension ties in every span. These run parallel to the bottom chords and are lifted up diagonally to the top chords above the piers. The forces are introduced into the structure with  $\varnothing$  32 mm DYWIDAG smooth bars. Deflection points and coupling splices of the bars were installed very simply and economically.

++++ DSI Services +++++  
supply of DYWIDAG bars,  
accessories and corrosion  
protection.

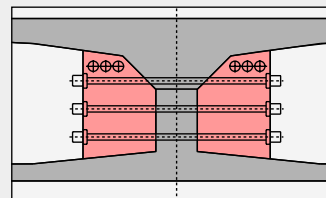

++++ DSI Services +++++  
study of the causes of the  
defects, preparation of the  
rehabilitation scheme, dimensioning of the strengthening system, supply and installation of the system, final control, acceptance test.



## Burlington Skyway, Ontario, Canada

This 2,560 m long steel bridge built in the mid 50's was repaired and strengthened in order to increase the number of lanes from four to five and to support the heavier design loads of the current codes.

The three main spans (84-151-84 m) consist of a continuous truss arch structure where the two longitudinal main trusses are connected by bracing bents and transverse floor trusses. These trusses support longitudinal deck stringers which in turn support a reinforced concrete deck. The transverse floor trusses consist of standard structural steel shapes riveted and bolted together. The increased loading resulted in significant overstressing of the transverse floor truss members. These trusses were strengthened by external post-tensioning using  $\varnothing$  36 mm DYWIDAG bars (THREADBAR®) and a limited addition of new structural steel. This method allowed a minimal number of members to be dismantled and eliminated the need for strict dimensional tolerances that would be required with the addition or replacement of truss members. The selected draped tendons were anchored in the deck slab to maximize their effectiveness. A unique steel plate assembly was bolted to the truss joint at the deviation point of the tendon to anchor the bars and transfer the tendon force to the truss. The bars were protected by a three coat zinc/vinyl paint system.



++++ DSI Services +++++  
supply of DYWIDAG bars (THREADBAR®), special anchorages and tensioning equipment, installation and stressing of the post-tensioning system.



++++ DSI Services +++++  
supply of DYWIDAG bars (THREADBAR®) and tensioning equipment.

## Cripple Creek Bridge, Highway 101, Ontario, Canada

Due to deterioration the entire superstructure of this steel-timber composite bridge was to be rehabilitated. The 3 single spans of 7-18-7 m consist of standard wide flange steel beams at 1.2 m spacing.

The existing transverse nail-laminated timber deck was replaced with a longitudinally laminated, transversely prestressed timber deck. The bridge was repaired in two stages to maintain one traffic lane at all times.

Transversely prestressed timber decks are stiffer and more durable than nail-laminated timber decks. Prestressing inhibits relative movements between the timber laminates and greatly improves wheel load distribution.

The transverse prestressing system consists of galvanized  $\varnothing$  26 mm DYWIDAG bars (THREADBAR®) placed at 300 mm spacing. Tensioning was repeated 1 week and 5 weeks after the initial stressing operation, to compensate for the large creep losses in the timber deck system. DYWIDAG bars (THREADBAR®) easily allow the repeated retensioning both at the time of construction, and in the future if necessary. Connecting of the tendons between the 1st and 2nd stage construction was accomplished by using standard couplers.



## ground anchors

### Strengthening of bridges

Columns, piers and tension ties can be strengthened using ground anchors. In this case the ground anchors act as external tendons to supply additional uplift capacity or to increase the tie force between different parts of the structure.

## Gänstor Bridge, Ulm, Germany

The frame legs of this two-hinged bridge were formed by vertical columns and inclined prestressed ties. After 30 years of service, cracks in the superstructure occurred. Surveying revealed some ungrouted ducts with corrosion of prestressing steel. Besides repair measures (vacuum grouting, injection of cracks, restoration of concrete surface and water proofing) three strengthening options were considered:

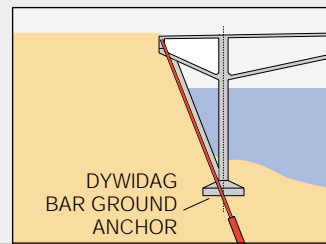

- strengthening by means of external tension ties in the form of permanent ground anchors
- strengthening with additional reinforced concrete and prestressed concrete elements

- strengthening of the superstructure applying external tendons.

After analysis of costs and efficiency of each variant and their aesthetic aspects, the variant with permanent ground anchors was chosen.

++++ DSI Services +++++  
survey of damages, determination of the actual load-bearing behavior, preparation of the repair/strengthening program, cost analysis, supply of  $\varnothing 26$  mm DYWIDAG ground anchors, realization of the repair/strengthening measures, control at commissioning.

## bar tendons

### Strengthening of historic buildings

Degradation of ancient building materials, prolonged exposure to environmental influences and uneven settlements make strengthening of historic buildings unavoidable. Furthermore, it must be considered that many historic buildings were built to a much lower degree of safety compared to similar modern structures. Strengthening measures must be integrated into the building without altering its character and appearance.



## San Lorenzo Cathedral, Perugia, Italy

The San Lorenzo Cathedral was built between the 14th and 15th centuries. Already in 1633-1641 important consolidation works had been carried out, since, because of the weight of the roof, the columns and the walls had diverged. Seismic movements in 1983 caused further damage, thus endangering the stability of the monument. A new consolidation and restoration project was decided after a thorough historical survey of the original and subsequent static behavior of the structure. The twenty-three timber roof trusses were reinforced by strengthening the joints with steel plates and bolts and by prestressing both

the lower tie beam and the central king post with two twin  $\varnothing 36$  mm DYWIDAG bars (THREADBAR®) each. The column capitals showed displacements of up to 26 cm. A new system of transverse and longitudinal ties made of DYWIDAG bars (THREADBAR®) was introduced into the columns and walls to prevent any side displacements. The transverse tie members were prestressed and tied back to the lateral walls in order to apply to the whole structure a system of acting forces capable of counteracting the thrusts of the vaults.

++++ DSI Services +++++  
supply of DYWIDAG bars (THREADBAR®), rental of equipment, technical assistance.



**GEWI® bars, bar tendons,  
bar stay cables**

**Modification / expansion of  
existing structures**

New demands on the use of structures, such as new lanes on the top or under a bridge or additional seats in a stadium, may require modification of the structural system or an extension of its size. GEWI® bars and DYWIDAG bar tendons with their excellent bond and fatigue strength properties are often used for these works.



**+++ DSI Services +++  
supply of GEWI® bars and  
piles.**

**Grandhotel  
Taschenbergpalais  
Kempinski, Dresden,  
Germany**

Built between 1707 and 1711, and completely destroyed by fire in 1945, this baroque palace is now the site of a luxury hotel. During construction of a 4-storey underground garage, the existing south façade, with a total weight of approx. 1,000 t, had to be supported 18 m above the foundation level. GEWI® bars with various diameters were used as tensioning and securing members. For the deep foundation of the western wing of the palace, GEWI® piles were drilled through the old cellar. The bond length of the piles is between 7 and 12 m.



**Santiago Bernabéu Soccer Stadium, Madrid, Spain**

To increase the number of seats, the roof structure had to be raised. The existing reinforced concrete columns were strengthened and extended. They were lengthened by 12.5 m high steel columns with steel trusses cantilevering to 32 m and anchored by  $\varnothing$  40 mm GEWI® bars. Six GEWI® bars were anchored in each foundation, four on the tension side of the columns and two in the front. This arrangement carries the uplift forces from wind loads on the roof which was placed on top of the extended columns.

**+++ DSI Services +++  
supply and installation of  
GEWI® bars.**



**16th Street Bridge over  
I-465, Indianapolis, USA**

Two new merging lanes were to be added to the highway under the existing bridge. Since the bridge was only ten years old and in excellent condition, it was decided to modify the structure by removing the end pier next to the south-bound lanes and replace it with a cable stayed support system. For this complex modification project, a number of DYWIDAG systems were used. The new 2 m wide transfer girder was prestressed with  $\varnothing$  32 mm DYWIDAG bar tendons (THREADBAR®).

**+++ DSI Services +++  
conceptual design, proposal  
for construction methods  
and sequence, supply of  
bar tendons and bar stay  
cables, field supervision.**

Vertical prestressing of the deadman pier shafts was executed with  $\varnothing$  36 mm DYWIDAG bar tendons (THREADBAR®) placed within a void to allow for longitudinal movements. To anchor the footings of the deadman piers against uplift forces of the stay cables  $\varnothing$  36 mm DCP DYWIDAG ground anchors were used. The stay cables consisted of eight  $\varnothing$  36 mm DYWIDAG bars (THREADBAR®) inside individual steel pipes, which were cement grouted after stressing.

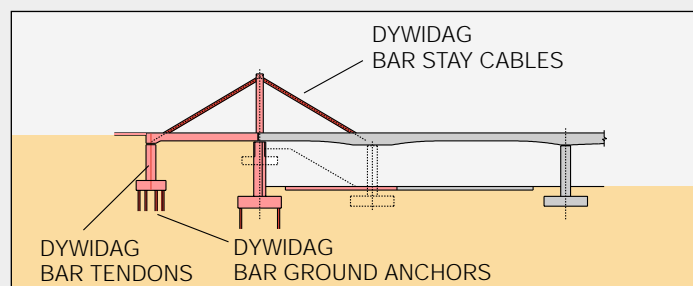

bar tendons, strand tendons

### Retrofitting of bridges

An essential seismic upgrading measure of bridges is to avoid the loss of support for the bearings due to large relative displacements between the superstructure and the substructure. These measures should not impede the free movement of the structure due to temperature variation or other effects. Often the existing pier cap beams must be widened and strengthened and the superstructure must be restrained to the support. Each of the following retrofittings made use of post-tensioning tendons to increase the stability of the structure.

**++++ DSI Services +++++ supply of DYWIDAG bars (THREADBAR®) and hardware.**

#### Elisian Viaduct, Los Angeles, California, USA

This bridge featured an old design concept of steel girders supported by concrete pier cap beams. The new retrofit design specified extensive use of bar tendons throughout the entire structure. The cap beam width was increased by adding new concrete on both sides. Transverse  $\varnothing$  32 mm DYWIDAG bars (THREADBAR®) connected new concrete to old. Steel girder stability was increased by adding special spreader beams bolted to the existing webs at several locations. Spreader beams placed in pairs were connected with an external restraint made of  $\varnothing$  32 mm bars (THREADBAR®).



## Seismic Upgrading

Structures have to withstand large horizontal and vertical accelerations and dynamic forces during earthquakes. This creates special requirements on the stiffness and load-bearing capacity of the structural members as well as on their connections. Many existing structures must be improved to survive future earthquakes. In California, following the Loma Prieta (1989) and Northridge (1994) earthquakes, approximately 1.300 concrete and steel structures needed seismic upgrading.

#### Altamount Sidehill Viaduct, Northern California, USA

Thirteen pier cap beams of this 440 m long bridge were retrofitted with twin-tierod groups connecting each side of the steel cap beam end to a new anchoring block. Tie rods, consisting of  $\varnothing$  36 mm DYWIDAG bars (THREADBAR®) placed inside of galvanized steel pipes, run inclined from the anchoring block to a special steel „shoe“ bracket fixed end. After a small post-tensioning force was applied at the anchorages, the tie rods were cement grouted.



**++++ DSI Services +++++ supply of DYWIDAG bars (THREADBAR®), hardware and stressing equipment.**

#### Los Angeles County, Intersection Freeway 10,57,210, California, USA

This very large superelevated freeway intersection required increased bearing capacity of the substructure to satisfy transversal flexural seismic demands. New post-tensioned transversal pier cap beams were added on each side and extended beyond the ends of the existing structure. Sixteen 15x0.6" tendons with DYWIDAG multiplane anchorages (MA) were installed. The upper tendons were conducted in pairs through holes drilled into the webs of the existing bridge girders. Large forces and confined space at some of the pier cap beams resulted in the first time use of DYWIDAG 37x0.62" strand tendons in California.



**++++ DSI Services +++++ supply, installation, stressing and grouting of DYWIDAG multistrand tendons.**

#### Cahuenga Boulevard Underpass, Los Angeles County, California

A new column was installed at the end of the pier cap beam to support an additional 3.6 m long concrete bolster, which increased flexural capacity. Post-tensioned strand tendons placed in parallel, on each side of the pier cap beam, connected new concrete to the existing box girders. A large steel bracket, attached to the bridge web at the tendon fixed end, allowed for uniform distribution of prestressing forces to the entire structure.



**++++ DSI Services +++++ supply, installation, stressing and grouting of DYWIDAG multistrand tendons.**



bar tendons GEWI® piles

### Retrofitting of buildings

Deficient structural systems or elements require strengthening to withstand future earthquakes. DYWIDAG bar tendons, with their easy and reliable anchorage and coupling systems, can be applied to upgrade these structures.



++++ DSI Services +++++  
supply of DYWIDAG bars (THREADBAR®), hardware and equipment.

### Oakland City Hall, Oakland, California, USA

This historic landmark in the San Francisco Bay Area was built in 1914. Since the Loma Prieta (1989) earthquake, the steel frame building with masonry infill has been completely rehabilitated. Due to the limited strength of the existing structure, the seismic isolation concept was applied. At that time it was the tallest seismically isolated building of the world.

Special base isolators were placed under each building column. The foundation thickness above the seismic isolators was increased by adding new concrete around the perimeter of all footings. The interaction between old and new concrete was improved with  $\varnothing$  32 mm DYWIDAG transverse bar tendons (THREADBAR®) that passed through cored holes.



### Glendale Post Office, Glendale, California, USA

This historic masonry building, serving as post office, was completely rehabilitated in 1995. New concrete shear walls were added to transmit forces during a seismic event. These were supported by  $\varnothing$  57 mm double corrosion protected (DCP) GEWI® piles which can be loaded with both tension and compression forces. During installation, limited head room conditions required the contractor to use small bar sections of 3 m connected with couplers.

++++ DSI Services +++++  
supply of GEWI® piles and stressing equipment.



### California State University, Long Beach Parking Structure, California, USA

Designed with precast prestressed girders, the structure was under construction during the Northridge earthquake.

A similarly designed parking structure which collapsed during this seismic event showed a lack of reinforcement at shear walls. Design engineers decided that short post-tensioned DYWIDAG bars (THREADBAR®), placed inside holes drilled along existing shear walls, would compensate for reinforcing steel deficiency.

++++ DSI Services +++++  
supply, installation, stressing and grouting of DYWIDAG bars (THREADBAR®).

## rock anchors

### Stabilizing of dams

Seismic performance of dams may be economically improved by adding rock anchors.

A large number of dams have already been stabilized using DYWIDAG multistrand anchors.

### Stewart Mountain Dam, Arizona, USA

The double curvature thin arch concrete structure was built in the 1920's and is approximately 64 m high. Retrofitting became necessary to prevent a possible failure of the arch section, in which a separation along the joints during a major seismic event would occur. That was a very real danger as, during construction, the concrete cold joints had not been properly cleaned of laitance, resulting in weak joints with little or no cohesion between pour sections. The solution was to stabilize the dam by installing sixty-two 22 x 0.62" DYWIDAG rock anchors in the arch section to restore monolithic action. A further 22 anchors were installed in the left thrust block to provide for enhanced stability against sliding. As the anchors were to be stressed and remain ungrouted for a 100 days monitoring period, protecting the strands against corrosion

became an extremely important consideration. The superior corrosion protection and high bond capacity of the Flo-Bond epoxy coated strand provided the ideal solution for both requirements.



+++ DSI Services +++  
consultancy during project,  
planning/quality management,  
supply, installation and testing of  
DYWIDAG rock anchors.



+++ DSI Services +++  
Supply of DYWIDAG rock anchors,  
uncoiling and stressing equipment.

### Railroad Canyon Dam, Canyon Lake, California, USA

The existing dam consisted of a thin 32 m high concrete arch section supported by concrete thrust blocks and concrete gravity wing walls. Earthquake specialists found that during Maximum Credible Earthquake water would probably overtop parapet walls, resulting in dam failure. For this reason each of the thrust blocks and wing walls were raised by adding new concrete. To increase stability, new and existing concrete was connected with anchors. The final design included six 27x0.6" and nine 48x0.6" DYWIDAG rock anchors with lengths up to 48 m. Flo-Fill/Flo-Bond epoxy coated strand was used for corrosion protection reasons. To allow for future load adjustment and long-term monitoring, special wedge plates with external thread and load cells were used.

ground anchors,  
GEWI® piles

### Retrofitting of foundations

In order to withstand the increased loading on structures during a major seismic event, DYWIDAG ground anchors as well as GEWI® piles are used to enhance bearing capacity and reduce foundation deformations.

+++ DSI Services +++  
supply of DYWIDAG bar anchors.

### Steel water tanks, Contra Costa County, California, USA

During a seismic event, the tank contents will move from side to side inducing dynamic uplifts on the tank foundations. To prevent damage at the foundation, high strength  $\varnothing$  25 mm and 32 mm DCP DYWIDAG bars (THREADBAR®) were used as tie down ground anchors around the steel tank perimeter.

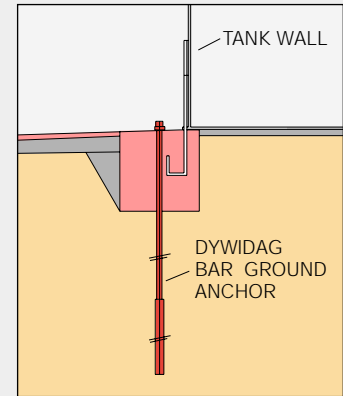

### Telecommunication tower, Diepenbeck, Belgium

The consultant decided to use DYWIDAG  $\varnothing$  32 mm bar tendons for rehabilitation of the existing anchors at the footing of the steel tower shaft. Since the foundation slab is supported by piles, the anchor plates for the lower anchorages could be mounted against the bottom side of the slab.



+++ DSI Services +++  
supply, installation, stressing  
and grouting of DYWIDAG  
bar tendons.



### Britannia Secondary School, Vancouver, British Columbia, Canada

In order to meet modern requirements on earthquake safety, this 70 year old building needed to be retrofitted. The designer chose high capacity  $\varnothing$  57 mm DCP GEWI® piles. Restricted by the low ceiling height in the building, the 15 m deep,  $\varnothing$  140 mm boreholes were drilled with a track-mounted hydraulic minidrilling rig. The anchors were coupled in sections from 2.7 m to 4 m. The tight restrictions of 2.7 m headroom, 0.60 m spacing at the pile head and pile inclinations of up to 40°, posed no problem for this very flexible installation method.

+++ DSI Services +++  
supply and installation of  
GEWI® piles.

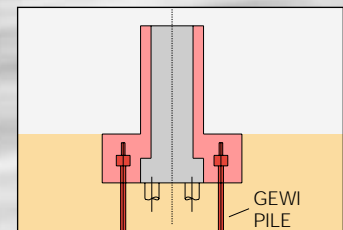

### Los Angeles River Bridges, Long Beach, California, USA

To prevent damage to foundations during seismic events, column thickness and footing width were increased.  $\varnothing$  57 mm GEWI® piles were installed to enhance load-bearing capacity.

+++ DSI Services +++  
supply of GEWI® piles and  
stressing equipment.



bars (THREADBAR®)

### Jacked sliding

Some rehabilitation schemes require the demolition and rebuilding of a portion of a structure.

A very efficient method to achieve this is to move the structure and then demolish it in its relocated position. This will result in little interruption in the function of the remaining structure and would allow an early start of the reconstruction. Another effective rehabilitation technique is to construct the new structure adjacent to the one to be demolished. After demolition is complete the new structure may be shifted in a very short time to its final location.

+++ DSI Services +++  
device development, supply  
and installation of the lifting  
system, pushing.

### Roof of a swimming hall, Marseille, France

Before a new roof of this swimming hall could be constructed, the old roof had to be removed. Traditional in-situ demolishing would have incurred very high scaffolding costs and long roof-raising times. The DYWIDAG alternative to this method was to disconnect the roof from its supporting columns and move it in seven-meter long sections. Once the butt end of the building, had been cleared the roof was demolished. That proved to be by far the quickest and most cost-effective solution.



### Marsh Mills Viaduct, Plymouth, England

Because of severe damage to the concrete from alkali-silica reactions, the entire structure had to be replaced. The new structure, a 410 m long, nine span and 5,500 t heavy dual carriageway road deck, was jacked sideways 12.2 m into position using Ø 36 mm DYWIDAG bars (THREADBAR®). Sliding was chosen as it minimized traffic disruption and was significantly cheaper than traditional methods. The new deck initially carried traffic while resting on temporary supports. After demolition of the old viaduct, eight new concrete piers

and two abutments were built to support the new deck. Road closure was limited to a weekend – eight hours for the slide, 24 hours to allow bearing grout to set and the remainder for asphaltting and traffic re-routing. The merge slide was downhill on a 2.85 % slope. Balance between pushing and pulling forces gave a controlled pulling force of up to 5,700 kN. Pulling was incremental, governed by the jack stroke of 600 mm, enabling a rate of travel of up to 1.8 m an hour.

## Lifting/Moving of Structures

Lifting and moving of structures can be advantageously used as part of a rehabilitation scheme:

- Lifting of structures as an easy strengthening measure: redistribution of the action effects in a statically indeterminate structure is achieved through imposed deformations (e.g. through lifting a continuous bridge at its supports)
- Moving of structures or portions of them through jacked sliding.

DYWIDAG bars (THREADBAR®) with their easy anchorage elements and mechanical coupling system are used as tension elements for lifting or moving heavy and complex structures. If required, DSI can assist you with the supply of special equipment and technical support.

+++ DSI Services +++  
supply of DYWIDAG bars  
(THREADBAR®).

**Austria**

DYWIDAG-SYSTEMS  
INTERNATIONAL GMBH  
Wagram 49  
4061 Pasching/Linz, Austria  
Phone +43-7229-61 04 90  
Fax +43-7229-61 04 980  
E-mail: alwag@dywidag-systems.com  
www.alwag.com

**DYWIDAG-SYSTEMS  
INTERNATIONAL GMBH**

Teichweg 9  
5400 Hallein, Austria  
Phone +43-6245-87 23 0  
Fax +43-6245-87 23 08 0  
E-mail: sekretariat@dywidag-systems.at  
www.dywidag-systems.at

**Belgium and Luxembourg**

DYWIDAG-SYSTEMS  
INTERNATIONAL N.V.  
Industrieweg 25  
3190 Boortmeerbeek, Belgium  
Phone +32-16-60 77 60  
Fax +32-16-60 77 66  
E-mail: info@dywidag.be

**France**

DSI-Artéon  
Avenue du Bicentenaire  
ZI Dagneux-BP 50053  
01122 Montluel Cedex, France  
Phone +33-4-78 79 27 82  
Fax +33-4-78 79 01 56  
E-mail: dsi.france@dywidag.fr  
www.dywidag-systems.fr

**Germany**

DYWIDAG-SYSTEMS  
INTERNATIONAL GMBH  
Schuetzenstrasse 20  
14641 Nauen, Germany  
Phone +49 3321 44 18 32  
Fax +49 3321 44 18 18  
E-mail: suspa@dywidag-systems.com

**DYWIDAG-SYSTEMS  
INTERNATIONAL GMBH**

Max-Planck-Ring 1  
40764 Langenfeld, Germany  
Phone +49 2173 79 02 0  
Fax +49 2173 79 02 20  
E-mail: suspa@dywidag-systems.com  
www.suspa-dsi.de

**DYWIDAG-SYSTEMS  
INTERNATIONAL GMBH**

Germanenstrasse 8  
86343 Koenigsbrunn, Germany  
Phone +49 8231 96 07 0  
Fax +49 8231 96 07 40  
E-mail: suspa@dywidag-systems.com

**DYWIDAG-SYSTEMS  
INTERNATIONAL GMBH**

Siemensstrasse 8  
85716 Unterschleissheim, Germany  
Phone +49-89-30 90 50-100  
Fax +49-89-30 90 50-120  
E-mail: dsihv@dywidag-systems.com  
www.dywidag-systems.com

**Please note:**

This brochure serves basic information purposes only. Technical data and information provided herein shall be considered non-binding and may be subject to change without notice. We do not assume any liability for losses or damages attributed to the use of this technical data and any improper use of our products. Should you require further information on particular products, please do not hesitate to contact us.

**Italy**

DYWIT S.P.A.  
Via Grandi, 68  
20017 Mazzo di Rho (Milano), Italy  
Phone +39-02-93 46 87 1  
Fax +39-02-93 46 87 301  
E-mail: info@dywit.it

**Netherlands**

DYWIDAG-SYSTEMS  
INTERNATIONAL B.V  
Veilingweg 2  
5301 KM Zaltbommel, Netherlands  
Phone +31-418-57 89 22  
Fax +31-418-51 30 12  
E-mail: email@dsi-nl.nl  
www.dsi-nl.nl

**Norway**

DYWIDAG-SYSTEMS  
INTERNATIONAL A/S  
Industrieveien 7A  
1483 Skytta, Norway  
Phone +47-67-06 15 60  
Fax +47-67-06 15 59  
E-mail: manager@dsi-dywidag.no

**Portugal**

DYWIDAG-SYSTEMS  
INTERNATIONAL LDA  
Rua do Polo Sul  
Lote 1.01.1.1 - 2B  
1990-273 Lisbon, Portugal  
Phone +351-21-89 22 890  
Fax +351-21-89 22 899  
E-mail: dsi.lisboa@dywidag.pt

**Spain**

DYWIDAG SISTEMAS  
CONSTRUCTIVOS, S.A.  
Avenida de la Industria, 4  
Pol. Ind. La Cantuena  
28947 Fuenlabrada (MADRID), Spain  
Phone +34-91-642 20 72  
Fax +34-91-642 27 10  
E-mail: dywidag@dywidag-sistemas.com  
www.dywidag-sistemas.com

**United Kingdom**

DYWIDAG-SYSTEMS  
INTERNATIONAL LTD.  
Northfield Road  
Southam, Warwickshire  
CV47 0FG, Great Britain  
Phone +44-1926-81 39 80  
Fax +44-1926-81 38 17  
E-mail: sales@dywidag.co.uk  
www.dywidag-systems.com/uk

AUSTRIA  
ARGENTINA  
AUSTRALIA  
BELGIUM  
BOSNIA AND HERZEGOVINA  
BRAZIL  
CANADA  
CHILE  
CHINA  
COLOMBIA  
COSTA RICA  
CROATIA  
CZECH REPUBLIC  
DENMARK  
EGYPT  
ESTONIA  
FINLAND  
FRANCE  
GERMANY  
GREECE  
GUATEMALA  
HONDURAS  
HONG KONG  
INDONESIA  
IRAN  
ITALY  
JAPAN  
KOREA  
LEBANON  
LUXEMBOURG  
MALAYSIA  
MEXICO  
NETHERLANDS  
NORWAY  
OMAN  
PANAMA  
PARAGUAY  
PERU  
POLAND  
PORTUGAL  
QATAR  
SAUDI ARABIA  
SINGAPORE  
SOUTH AFRICA  
SPAIN  
SWEDEN  
SWITZERLAND  
TAIWAN  
THAILAND  
TURKEY  
UNITED ARAB EMIRATES  
UNITED KINGDOM  
URUGUAY  
USA  
VENEZUELA

[www.dywidag-systems.com](http://www.dywidag-systems.com)